

Boutique

Collection
2024



The Art of Lifestyle
designed in Germany

Inhalt Content · Contenu

4 Brillenetuis / Spectacle Cases / Étuis à lunettes

6 Schlüsselanhänger / Keychains / Porte-clés

8 Pillendosen / Pillboxes / Boîtes à pilules

9 Taschenspiegel / Pocket Mirrors / Miroirs de poche

10 Regenschirme / Umbrellas / Parapluies

12 Gobelintaschen / Tapestry Fabric Bags / Sacs de tissus de tapisserie

14 Einkaufstaschen / Shopping Bags / Sacs à courses

16 Bijoux del Arte

23 Werbemittel / Advertising Material / Matériel PLV

Boutique



Mit unserer Goebel Boutique-Kollektion präsentieren wir Ihnen eine Reihe hochwertiger Geschenkartikel und Mode-Accessoires. Die Designs, wie z.B. berühmte historische Motive aus dem Impressionismus und Jugendstil oder der gegenwärtigen Kunst, werden von kreativen Köpfen unserer Designer auf zeitgemäße Formen adaptiert. So entstehen charmante, stilvolle Objekte - zum Verschenken oder für den kleinen persönlichen Luxus.

With our Goebel Boutique collection we present a variety of high-quality gift items and fashion accessories. The designs, such as well-known historical motifs from Impressionism and Art Nouveau or contemporary art, are adapted to modern forms by the creative minds of our designers. This is how charming, stylish objects are created - to give as gifts or for a little personal luxury.

Avec notre collection Goebel Boutique, nous vous présentons une variété de cadeaux et d'accessoires de mode de haute qualité. Les motifs, tels que les célèbres motifs historiques de l'impressionnisme et de l'art nouveau ou l'art contemporain, sont adaptés à des formes contemporaines par les esprits créatifs de nos designers. Il en résulte des objets charmants et élégants, à offrir ou à s'offrir.

▲ = Promotion

★ = Solange der Vorrat reicht
While stock lasts
Jusqu'à l'épuisement du stock

Brillenetuis

Spectacle Cases · Étuis à lunettes



- Stabile, mit Stoff bezogene Hartschale
- Angenehme Haptik
- Sicherer Klickverschluss
- Weiche Filzauskleidung
- Perfekt für alle gängigen Brillengrößen geeignet
- Inkl. Mikrofaser-Reinigungstuch 14,5 x 17,5 cm
- Lieferung in attraktivem Geschenkkarton

- Solid hard-shell case with fabric cover
- Pleasant touch
- Strong, secure metal hinge
- Lined with soft felt
- For all common sizes of glasses 14,5 x 17,5 cm
- Attractive gift box

- Coque solide, recouverte de tissu
- Toucher agréable
- Fermeture à clic sécurisée
- Revêtement en feutre doux
- Pour toutes tailles de lunettes courantes
- Avec chiffon en microfibres 14,5 x 17,5 cm
- Emballage cadeau



Louis Comfort Tiffany
Schmetterlinge

16 x 4,5 cm

67-003-01-1

VE2

23.000998.0.295.1



4 005169 363924



Neu | New | Nouveau

Ed Heck
Lookin' Cool

16 x 4,5 cm

67-200-14-1

VE2

24.000998.0.538.4



4 005169 368622



Claude Monet
Das Künstlerhaus
16 x 4,5 cm
67-060-94-1 VE2
19.000998.0.890.7



4 005169 330865



Vincent van Gogh
Mandelbaum Blau
16 x 4,5 cm
67-060-92-1 VE2
19.000998.0.899.1



4 005169 330841



Jan Davidsz de Heem
Sommerblumen
16 x 4,5 cm
67-061-65-1 VE2
21.000998.0.308.1



4 005169 352393



Alphonse Mucha
Frühling
16 x 4,5 cm
67-062-38-1 VE2
23.000998.0.870.7



★
4 005169 363931



Gustav Klimt
Der Kuss
16 x 4,5 cm
67-061-15-1 VE2
20.000998.0.860.1



4 005169 344060



Gustav Klimt
Der Lebensbaum
16 x 4,5 cm
67-060-91-1 VE2
19.000998.0.860.1



4 005169 330834



Lotus
Yin Yang Schwarz
16 x 4,5 cm
23-500-47-1 VE2
20.000998.0.684.7



★
4 005169 343964



Lotus
Blume des Lebens Weiß
16 x 4,5 cm
23-500-48-1 VE2
20.000998.0.684.7



4 005169 343971



Dr. Barbara Freundlieb
I Need Vitamin Sea
16 x 4,5 cm
27-000-79-1 VE2
20.000998.0.270.7



★
4 005169 342639

Schlüsselanhänger

Schlüsselanhänger / Kunststoff
Keychains / Plastic
Porte-clés / Synthétique



Neu | New | Nouveau

Love Dog

Schlüsselanhänger
Keychain / Porte-clés
5 cm
67-200-04-1 VE10
24.000498.0.538.4



Neu | New | Nouveau

Roar

Schlüsselanhänger
Keychain / Porte-clés
5 cm
67-200-05-1 VE10
24.000498.0.538.4



Neu | New | Nouveau

Duck Gone Wild

Schlüsselanhänger
Keychain / Porte-clés
5 cm
67-200-06-1 VE10
24.000498.0.538.4



Neu | New | Nouveau

When Pigs Fly

Schlüsselanhänger
Keychain / Porte-clés
5 cm
67-200-07-1 VE10
24.000498.0.538.4



Neu | New | Nouveau

W.T.F. - What the Fuck!

Schlüsselanhänger
Keychain / Porte-clés
ø 5 cm
67-180-14-1 VE10
24.000498.0.288.4



Neu | New | Nouveau

I Love it!

Schlüsselanhänger
Keychain / Porte-clés
ø 5 cm
67-180-13-1 VE10
24.000498.0.288.4



Neu | New | Nouveau

OMG! - Oh my God!

Schlüsselanhänger
Keychain / Porte-clés
ø 5 cm
67-180-15-1 VE10
24.000498.0.288.4



Satz | Set

James Rizzi
 Schlüsselanhänger
 Keychains / Porte-clés
 Kunststoff / Plastic / Synthétique
 Display 34 x 12 x 13 cm
 26-103-30-1 4x6 Stck./Pcs.
 23.011940.0.907.7



James Rizzi
 Peace Heart
 5,5 x 5 cm
 26-103-26-1 VE6
 23.000498.0.907.7



James Rizzi
 Rizzi Bird
 6 x 5 cm
 26-103-27-1 VE6
 23.000498.0.907.7



James Rizzi
 Unexpected Company
 6,5 x 5 cm
 26-103-28-1 VE6
 23.000498.0.907.7



James Rizzi
 A Funny Sunny Day
 5,5 x 4 cm
 26-103-29-1 VE6
 23.000498.0.907.7

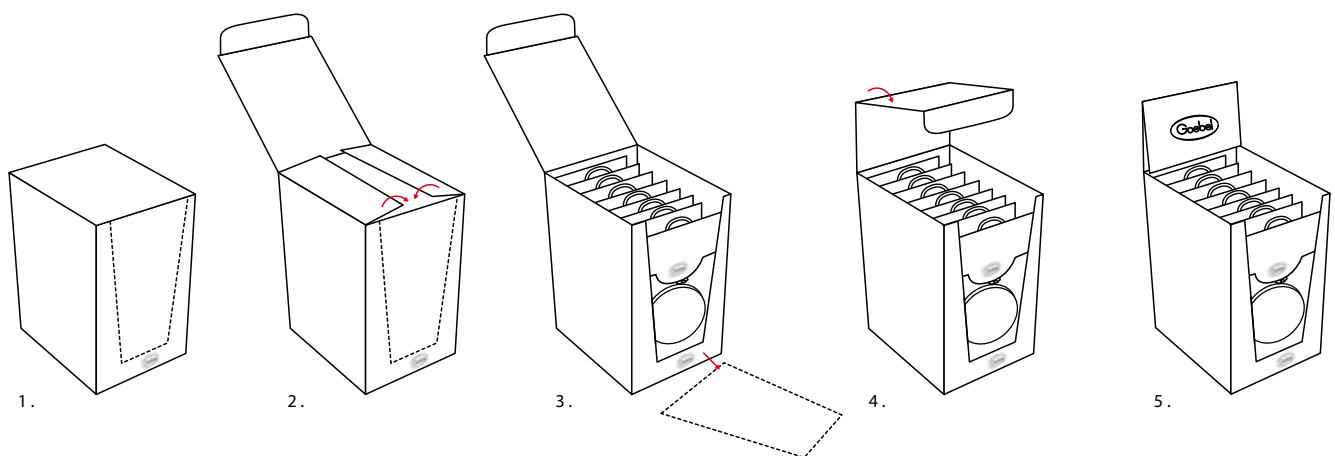

Verpackung als Display nutzbar.
 Packaging can be used as a Display.
 L'emballage peut être utilisé comme présentoir.

Pillendosen

Pillboxes · Boîtes à pilules

- Material: Metall mit Kunststoff
- Tabletteneinsatz 3teilig aus Kunststoff
- Zum Aufbewahren von Medikamenten bzw. kleinen Utensilien
- Druckknopf zum Öffnen der Dose
- Material: metal with plastic
- Pill inlay with 3 compartments made of plastic
- For medication or small utensils
- Push button for easy opening
- Matière: métal avec plastique
- Pilulier avec 3 compartiments en plastique
- Pour les médicaments ou les petits ustensiles
- Bouton poussoir pour ouvrir la boîte

Artis Orbis
 Display für Pillendosen
 Display for Pillboxes
 Display pour boîte à pilules
 Display 28 x 9 x 9,5 cm
 ohne Artikel
 without items / Display vide
 67-066-06-1 VE1



Ab einer Bestellung von 20 Artikeln (5 x 4 Stck.) erhalten Sie kostenlos ein Display zur optimalen Präsentation.
 When placing an order of 20 articles (5 x 4 pcs.) or more you will get one free display for perfect presentation.
 Affichage gratuit à partir d'une commande de 20 pcs.



Gustav Klimt
 Der Kuss
 ø 5 cm
 67-066-04-1 VE4
 18.000448.0.860.1



Gustav Klimt
 Der Lebensbaum
 ø 5 cm
 67-066-05-1 VE4
 18.000448.0.860.1



Alphonse Mucha
 Frühling
 5 cm
 67-062-44-1 VE4
 23.000448.0.870.7



Louis Comfort Tiffany
 Schmetterlinge
 5 cm
 67-003-05-1 VE4
 23.000448.0.295.1



Claude Monet
 Das Künstlerhaus
 ø 5 cm
 67-066-08-1 VE4
 20.000448.0.890.1



Jan Davidsz de Heem
 Sommerblumen
 ø 5 cm
 67-061-45-1 VE4
 21.000448.0.308.1



Neu | New | Nouveau
 Lotus
 Ginkgo Schwarz
 ø 5 cm
 23-500-87-1 VE4
 24.000448.0.684.4



Taschenspiegel

Pocket Mirrors · Miroirs de poche

- Material: Metall und Glas
- Spiegel und Vergrößerungsspiegel (1:2)
- Druckknopf zum Öffnen des Spiegels
- Material: Metal and glass
- Regular mirror and magnifying mirror (1:2)
- Push button for easy opening
- Matière : Métal et verre
- Miroir et miroir grossissant (1:2)
- Bouton poussoir pour ouvrir le miroir



Gustav Klimt
Der Kuss
ø 7,5 cm
67-060-41-1 VE4
17.000498.0.860.1



Gustav Klimt
Der Lebensbaum
ø 7,5 cm
67-060-43-1 VE4
17.000498.0.860.1



Gustav Klimt
Adele Bloch-Bauer
ø 7,5 cm
67-060-42-1 VE4
17.000498.0.860.1



Vincent van Gogh
Mandelbaum
ø 7,5 cm
67-060-45-1 VE4
17.000498.0.899.1



Alphonse Mucha
Frühling
ø 7,5 cm
67-062-45-1 VE4
23.000498.0.870.7



Louis Comfort Tiffany
Schmetterlinge
ø 7,5 cm
67-003-06-1 VE4
23.000498.0.295.1



Claude Monet
Seerosen am Abend
ø 7,5 cm
67-060-47-1 VE4
17.000498.0.890.1



Jan Davidsz de Heem
Sommerblumen
ø 7,5 cm
67-061-44-1 VE4
21.000498.0.308.7



Artis Orbis
Display für Taschenspiegel
Display for Pocket Mirror
Display pour miroirs de poche
Display 33 x 9 x 9 cm
ohne Artikel / without items / Display vide
67-060-32-1 VE1



Ab einer Bestellung von 16 Artikeln (4 x 4 Stck.) erhalten Sie kostenlos ein Display zur optimalen Präsentation.
When placing an order of 16 articles (4 x 4 pcs.) or more you will get one free display for perfect presentation.
Affichage gratuit à partir d'une commande de 16 pcs.

Upside/Down Schirme

Upside-Down Umbrellas · Parapluies avec ouverture à l'envers



Die Schirmkuppel entfaltet sich von oben nach unten, nicht wie üblicherweise von unten nach oben. Die innovative zweilagige Konstruktion ermöglicht eine Upside-Down-Technik. So wird beim Zusammenfallen des Schirms die nasse Außenseite nach innen gezogen und die Regentropfen sind somit eingeschlossen - kein lästiges Tropfen mehr!

The traditional umbrella has been turned upside down and inside out. This is possible with an innovative two-layer construction. When folding the umbrella, the wet outside is being pulled inside and the raindrops cannot pour out - all the wetness stays inside.

Le parapluie traditionnel réinventé dans le sens envers, avec une construction astucieuse en deux couches de textile. En fermant le parapluie, le côté mouillé est tiré à l'envers et à l'intérieur et l'humidité reste dedans.



- Material: Stoff, synthetisch
- Stockschirm mit Upside/Down Öffnung!
- Zweilagig bespannt und sturmfest
- Nasse Seite klappt nach innen
- Freistehend

- Material: Textile, synthetic
- Stick umbrella with upside/down opening
- Double layered and storm proof
- Wet side folds inwards
- Freestanding

- Matière: Textile synthétique
- Parapluie-canne avec ouverture à l'envers
- Double couche et résistant aux tempêtes
- Le côté humide se replie vers l'intérieur
- Stable, ne tombe pas



Video



Louis Comfort Tiffany
Schmetterlinge
80 cm / Ø 108 cm
67-001-54-1
22.001998.0.295.7



Gustav Klimt
Der Kuss
80 cm / Ø 108 cm
67-060-68-1
18.001998.0.860.1

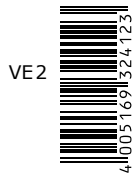

Neu | New | Nouveau

Claude Monet
Seerosen mit Weide
80 cm / Ø 108 cm
67-062-72-1
24.001998.0.890.4



Wassily Kandinsky
Farbstudie
80 cm / Ø 108 cm
67-062-22-1
23.001998.0.299.1



Jan Davidsz de Heem
Sommerblumen
80 cm / Ø 108 cm
67-061-66-1
21.001998.0.308.1

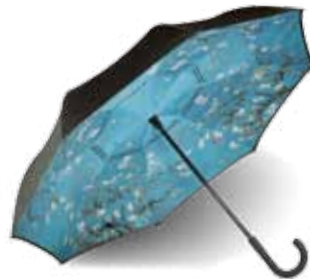

Vincent van Gogh
Mandelbaum Blau
80 cm / Ø 108 cm
67-061-13-1
20.001998.0.899.1



Vincent van Gogh
Sonnenblumen
80 cm / Ø 108 cm
67-062-21-1
23.001998.0.899.1



Neu | New | Nouveau

Mauro Bergonzoli
Magic Bunny
Explosion
80 cm / Ø 108 cm
67-180-05-1
24.001998.0.288.4



Neu | New | Nouveau

James Rizzi
Desert Life
80 cm / Ø 108 cm
26-103-34-1
24.001998.0.907.4



James Rizzi
My New York City
Sunset
80 cm / Ø 108 cm
26-102-53-1
20.001998.0.907.1



Billy The Artist
Bright Eyes
80 cm / Ø 108 cm
67-080-72-1
23.001998.0.286.7

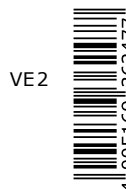



Gobelintaschen

Tapestry Fabric Bags
Sacs de tissus de tapisserie

- Hochwertige Gobelin-Stoffe, mit Kunstleder kombiniert
- Motive sind eingewebt
- Produkt ist edel, dicht und strapazierfähig
- Mit Reißverschluss und 2 zusätzlichen Innenfächern

- High quality tapestry fabrics combined with leatherette
- Motifs are woven in
- Product is elegant, tight and durable
- With zipper and 2 additional inner compartments

- Fabriqué de tissus de tapisserie de haute qualité
- Les motifs ne sont pas imprimés, mais tissés
- Le produit final est non seulement noble, mais aussi dense et durable
- Avec fermeture éclair et 2 compartiments intérieurs supplémentaires

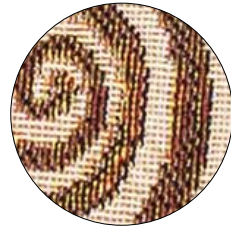
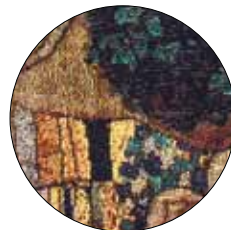

Handtaschen · Bags · Sacs à mains

Geräumiger, alltagstauglicher Shopper mit Reißverschluss und Innenfächern für Handy und Kleingeld.

Spacious shopper for everyday use with zip and inner compartments for mobile phone and change.

Un sac spacieux pour l'usage quotidien avec fermeture éclair et compartiments intérieurs pour le téléphone portable et la monnaie.



Gustav Klimt
Der Kuss

38 x 13 x 27 cm
67-061-70-1
23.003750.0.860.1

VE 1



4 005169 354595



Gustav Klimt
Der Lebensbaum

38 x 13 x 27 cm
67-061-69-1
21.003750.0.860.1

VE 1



4 005169 354588



Claude Monet
Mohnfeld

38 x 13 x 27 cm
67-061-92-1
22.003750.0.890.1

VE 1



4 005169 359996



Katsushika Hokusai
Die Welle

38 x 13 x 27 cm
67-061-96-1
22.003750.0.552.1

VE 1



4 005169 360039

Kosmetiktaschen · Makeup Bags · Trousses

Mit Reißverschluss und 2 zusätzlichen Innenfächern · With zip and 2 additional inner compartments

Avec fermeture éclair et 2 compartiments intérieurs supplémentaires



Gustav Klimt
Der Kuss

25 x 8 x 6 cm
67-062-29-1
23.001248.0.860.1

VE 1



4 005169 363269



Gustav Klimt
Der Lebensbaum

25 x 8 x 6 cm
67-061-73-1
21.001248.0.860.1

VE 1



4 005169 354625



Claude Monet
Mohnfeld

25 x 8 x 6 cm
67-061-94-1
22.001248.0.890.1

VE 1



4 005169 360015



Katsushika Hokusai
Die Welle

25 x 8 x 6 cm
67-061-98-1
22.001248.0.552.1

VE 1



4 005169 360053

Umhängetaschen · Shoulder bags · Sacs à bandoulière

Mit Reißverschluss und 2 zusätzlichen Innenfächern · With zip and 2 additional inner compartments

Avec fermeture éclair et 2 compartiments intérieurs supplémentaires



Gustav Klimt
Der Kuss

25 x 5 x 19 cm
67-062-28-1
23.002248.0.860.1

VE 1



4 005169 363252



Gustav Klimt
Der Lebensbaum

25 x 5 x 19 cm
67-061-71-1
21.002248.0.860.1

VE 1



4 005169 354601



Claude Monet
Mohnfeld

25 x 5 x 19 cm
67-061-93-1
22.002248.0.890.1

VE 1



4 005169 360008



Katsushika Hokusai
Die Welle

25 x 5 x 19 cm
67-061-97-1
22.002248.0.552.1

VE 1



4 005169 360046

Einkaufstaschen

Einkaufstaschen
mit Innentasche / Kunststoff
Shopping Bags with
inner compartment / Plastic
Sacs à courses
avec compartiment
intérieur / Synthétique



Goebel Porzellan
Goebel Design Bunt
37 x 12 x 33,5 cm
96-963-61-1 VE25
19.000198.0.981.1



Goebel Porzellan
Goebel Design Neutral
25 x 20 x 40 cm
96-963-17-1 VE25
18.000068.0.981.1



Gustav Klimt
Der Kuss
37 x 12 x 33,5 cm
67-061-16-1 VE10
20.000248.0.860.1



Gustav Klimt
Der Lebensbaum
37 x 12 x 33,5 cm
67-061-05-1 VE10
19.000248.0.860.1



Alphonse Mucha
Frühling
37 x 12 x 33,5 cm
67-062-36-1 VE10
23.000248.0.870.7



Neu | New | Nouveau

Claude Monet
Seerosen mit Weide
37 x 12 x 33,5 cm
67-062-71-1 VE10
24.000248.0.890.4



Claude Monet
Das Künstlerhaus
37 x 12 x 33,5 cm
67-062-37-1 VE10
23.000248.0.890.1

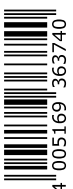

Jan Davidsz de Heem
Sommerblumen
37 x 12 x 33,5 cm
67-062-61-1 VE10
23.000248.0.308.1





Neu | New | Nouveau

James Rizzi
Desert Life
37 x 12 x 33,5 cm
26-103-33-1 VE10
24.000248.0.907.4



James Rizzi
My New York City
Sunset
37 x 12 x 33,5 cm
26-102-81-1 VE10
21.000248.0.907.1



James Rizz
Not Getting
Around the Traffic
37 x 12 x 33,5 cm
26-102-49-1 VE10
21.000248.0.907.1



Neu | New | Nouveau

Mauro Bergonzoli
Magic Bunny Explosion
37 x 12 x 33,5 cm
67-180-07-1 VE10
24.000248.0.288.4



Billy The Artist
Evolution of Love I
37 x 12 x 33,5 cm
67-080-81-1 VE10
24.000248.0.286.4



Billy The Artist
Together
37 x 12 x 33,5 cm
67-080-66-1 VE10
21.000248.0.286.7



Neu | New | Nouveau

Dr. Barbara Freundlieb
Ich muss gar Nix
37 x 12 x 33,5 cm
27-001-44-1 VE10
24.000248.0.270.4



Scandic Home
Lighthouse
37 x 12 x 33,5 cm
23-101-61-1 VE10
21.000248.0.235.7



Lana Frey
Fire in the Belly
37 x 12 x 33,5 cm
67-170-06-1 VE10
23.000248.0.278.1



Bijoux del Arte



Alle Artikel werden in hochwertigen Geschenkverpackungen geliefert, die auch als Display verwendet werden können.

All jewelry items are furnished with attractive gift boxes which can be also used as a display.

Tous les articles sont fournis dans des boîtes-cadeaux de haute qualité qui peuvent également être utilisées comme présentoir.

Halskette in runder Form

- Amulett: Porzellan, mit Echtgold veredelt
- Handbemalt
- Mit handgesetztem Kristallstein
- Clip und Verschluss: Messing, nickelfrei
- Textilband ca. 58 cm
- Beidseitig dekoriert

- Amulet: Porcelain, decorated with genuine gold
- Hand painted
- With hand-set crystal
- Clip and fastener: brass, nickel-free
- Textile necklace 58 cm
- Front and back decorated

- Pendentif: Porcelaine, décorée avec or véritable
- Peint à la main
- Avec cristal serti à la main
- Le clip ne contient pas de nickel
- Fermeture en laiton sans nickel
- Bande textile ca. 58 cm
- Décoré sur deux côtés



Gustav Klimt
Der Kuss*
ø 5 cm
66-989-57-5 VE1
13.002498.0.860.1



Gustav Klimt
Adele Bloch-Bauer*
ø 5 cm
66-989-58-3 VE1
13.002498.0.860.1



Gustav Klimt
Die Erfüllung*
ø 5 cm
66-989-60-9 VE1
13.002498.0.860.1



Gustav Klimt
Judith I*
ø 5 cm
66-989-59-1 VE1
13.002498.0.860.1



Vincent van Gogh
Mandelbaum Blau*
ø 5 cm
66-989-63-3 VE1
14.002498.0.899.1



Katsushika Hokusai
Die Welle*
ø 5 cm
66-989-94-8 VE1
15.002498.0.552.1



Premium Kette

- Amulett Porzellan mit Echtgold / Platin veredelt
- Mit 8 handgesetzten Kristallsteinen
- Kette und Metallkomponenten aus Messing, vergoldet bzw. Messing mit weißer Bronzebeschichtung, nickelfrei und antiallergisch
- Kettenlänge 58 cm
- Einseitig dekoriert
- Amulet Porcelain decorated with genuine gold / platinum
- With 8 hand-set crystal stones
- Material of chain and metal components: Brass, gold plated or brass, white bronze plated, nickel-free and anti-allergic
- Necklace 58 cm
- Decorated from one side
- Pendentif Porcelaine décorée avec or et platine véritable
- Avec 8 cristaux serts à la main
- Chaîne et composants métalliques en laiton, plaqués or ou laiton avec revêtement en bronze blanc, sans nickel et antiallergiques
- Bande 58 cm
- Décoré sur un côté



Gustav Klimt
Der Kuss
8 cm / ø 4,5 cm
67-045-41-1 VE1
21.004950.0.860.7



Gustav Klimt
Der Lebensbaum
8 cm / ø 4,5 cm
67-045-33-1 VE1
21.004950.0.860.7



Vincent van Gogh
Mandelbaum Blau
8 cm / ø 4,5 cm
67-045-25-1 VE1
21.004950.0.899.7



Vincent van Gogh
Mandelbaum Silber
8 cm / ø 4,5 cm
67-045-37-1 VE1
21.004950.0.899.7



Katsushika Hokusai
Die Welle
8 cm / ø 4,5 cm
67-045-21-1 VE1
22.004950.0.552.7



Robert Delaunay
Lebensfreude
8 cm / ø 4,5 cm
67-045-29-1 VE1
22.004950.0.294.7



Halsketten in asymmetrischer Form

- Amulett Porzellan
- Mit Gold bzw. Platin veredelt
- Handbemalt
- Mit handgesetztem Kristallstein
- Clip und Verschluss Messing, nickelfrei
- Textilband 80 cm
- Beidseitig dekoriert

- Amulet Porcelain decorated with genuine gold / with platinum
- Hand painted
- With hand-set crystal
- Clip and fastener brass, nickel-free
- Textile necklace 80 cm
- Front and back decorated

- Pendentif Porcelaine décorée avec or véritable et platine véritable
- Peint à la main
- Avec cristal serti à la main
- Le clip ne contient pas de nickel
- Fermeture en laiton sans nickel
- Bande textile 80 cm
- Décoré sur deux côtés



Rosina Wachtmeister
Principe ranocchio*
ø 5 cm
66-852-68-1 VE1
20.003750.0.731.7



Rosina Wachtmeister
Melograni in festa*
ø 5 cm
66-852-69-1 VE1
20.003750.0.731.7



Die hochwertige Geschenkverpackungen mit Samteinlage wird durch einfaches Umklappen zur perfekten Präsentationhilfe.

The high-quality gift box with velvet inlay change into the perfect presentation aid simply by folding them over.

Les boîtes-cadeaux de haute qualité avec incrustation de velours deviennent une aide de présentation parfaite en les repliant tout simplement.



*Vorder- und Rückansicht / Front and back view
Recto/Verso

Noël by Lamart



Glamouröse Broschen zu Weihnachten

Die Broschen von Noël by Lamart verleihen Ihrer festlichen Garderobe ein ganz besonderes Highlight. Passend zum Anlass funkeln und glitzern die Schmuckstücke in einer Vielzahl farbenfroher Kristallsteine. Die Motive reichen dabei von festlich bis verspielt und präsentieren mit jedem einzelnen Design die Freude und den Glanz der Weihnacht.

Glamorous Broochs for Christmas
The broochs of Noël by Lamart definitely put a highlight on your festive robes. Perfectly suitable for the occasion the jewellery sparkles in various colourful crystals. All decorative designs from classy to playful present the joy and glamor of Christmas.

Des broches glamour pour un Noël inoubliable

Les broches de Noël by Lamart ajoutent une touche particulière à votre robe de fête. En harmonie avec l'occasion, les bijoux brillent et scintillent grâce à une multitude de pierres de cristal colorées. Les motifs varient de festifs à ludiques et illustrent avec chaque design la joie et la splendeur de Noël.

- Brosche: Zinklegierung
- Nadel: Messing
- Handgesetzte Kristallsteine
- Gold und Rhodium veredelt

- Brooch zink alloy
- Brass needle
- Hand decorated crystals
- gold and rhodium decorated

- Broche alliage de zinc
- Aiguille de laiton
- Cristaux disposés à la main
- Affiné avec or et rhodium



★
 Schleife mit roten Glocken
 Bow with Red Bells
 Nœud avec cloches rouges
 3 x 4,5 cm
 51-001-42-1 VE1
 20.001248.0.598.7



★
 Glocke Gold
 Bell Gold
 Cloches or
 3 x 3,5 cm
 51-001-13-1 VE1
 19.001248.0.598.7



★
 Reh
 Deer
 Chevrenil
 5,5 x 4,5 cm
 51-000-55-1 VE1
 18.001248.0.598.7



★
 Baum Rot-Grün
 Tree Red-Green
 Arbre rouge-vert
 5 x 7 cm
 51-000-66-1 VE1
 18.001498.0.598.7



★
 Baum Gold-Rot
 Tree Gold-Red
 Sapin or-rouge
 4,5 x 6 cm
 51-001-38-1 VE1
 20.001498.0.598.7



★
 Kranz mit Glocke
 Wreath with Bell
 Couronne avec cloche
 4 x 4 cm
 51-000-52-1 VE1
 18.001248.0.598.7



★
 Kranz mit roter Schleife
 Wreath with Red Bow
 Couronne avec nœud rouge
 4 x 4 cm
 51-001-12-1 VE1
 19.001498.0.598.7



★
 Schneemann
 Snowman
 Bonhomme de neige
 4,5 x 4,5 cm
 51-001-37-1 VE1
 20.001498.0.598.7



Materialinformation

Goebel Modeschmuck ist aus Porzellan und mit hochwertigen keramischen Kunstdrucken, Echthgoldauflagen und Kristallsteinen dekoriert. Die Metallkomponenten sind antiallergisch, nickelfrei und vergoldet.

Pflegehinweise

Um möglichst lange Freude an Ihrem Schmuckstück zu haben, bewahren Sie dies am besten einzeln in der Originalverpackung oder in einer Schatulle mit separaten Schmuckfächern auf. Beachten Sie bitte auch, daß Chlor- und Salzwasser, Sonnencreme, starke Sonneneinstrahlung, Schweiß, sowie Haarspray, Parfüm und andere Kosmetika die empfindliche Oberfläche Ihrer Schmuckstücke angreifen können. Vergoldete Metalle können nach langem Tragen anlaufen.

Material Information

Goebel costume jewellery of porcelain is decorated with high quality ceramic art prints, genuine gold ornaments and crystal stones. The metal components are anti-allergic, nickel-free and gold coated.

Care-instructions

We recommend to store your Goebel costume jewellery in the original gift box or in a jewel case with separate trays. Chlorine and salt water, sun lotion, sweat, hair spray, perfume and other cosmetics may damage the sensitive surface of your jewellery pieces. Gold plated metal parts may tarnish after long wearing.

Spécifications techniques

Les bijoux de Goebel sont produits en porcelaine fine et décorés de lithographies d'art céramiques, avec des éléments d'or mat de cristal et des pierres. Les éléments en métal sont anti-allergiques et dorés sans nickel.

Conseils de nettoyage

Nous conseillons de garder vos bijoux Goebel en emballage cadeaux original ou dans votre boîte bijoux avec rangements séparés. Le décor des bijoux peut être endommagé par l'eau salée ou chlorique, des lotions solaires, de la sueur, laque des cheveux, parfums ou autres produits cosmétiques. Les éléments en métal doré peuvent se ternir après long usage.



Werbemittel / Advertising Material / Matériel PLV



Neu | New | Nouveau
 Endverbraucherflyer
 Consumer Flyer 2024
 Dépliant consommateur
 Goebel Porzellan - **D**
 mit Preisen
 with price list / avec prix
 15 x 15 cm
 96-968-79-1 VE20



Neu | New | Nouveau
 Endverbraucherflyer
 Consumer Flyer 2024
 Dépliant consommateur
 Goebel Porzellan - **GB / F**
 ohne Preise
 without price list / sans prix
 15 x 15 cm
 96-968-80-1 VE20



Schmuckbüste
 Jewellery Bust
 Buste à bijoux
 30 cm
 96-963-41-1 VE1
 18.001023.0.981.1



Schmuckbüste
 Jewellery Bust
 Buste à bijoux
 26 cm
 96-963-42-1 VE1
 18.000796.0.981.1



Schmuckbüste **
 Jewellery Bust
 Buste à bijoux
 30 cm
 96-963-19-1 VE1



Schmuckbüste **
 Jewellery Bust
 Buste à bijoux
 26 cm
 96-963-20-1 VE1



** ohne Berechnung, im Schmuckpaket enthalten
 free of charge, included in the jewellery set
 sans facturation, contenu dans le kit de bijoux

stay informed and
join our social network



WEEE-Reg. Nr.: DE71817340

Änderungen und Irrtümer vorbehalten.
Errors and omissions excepted.
Sauf erreur ou omission.

© Goebel
Goebel Porzellan GmbH
Auwaldstraße 8
96231 Bad Staffelstein
Tel.: 09563 / 92-0
E-Mail: goebel@goebel.de
www.goebel.de

96-968-77-1

